

Smart Sprinkler Controller

YS4102-UC

Quick Start Guide

Revision Jan. 17, 2023

A Welcome!

Thank you for purchasing YoLink products! We appreciate you trusting YoLink for your smart home & automation needs. Your 100% satisfaction is our goal. If you experience any problems with your installation, with our products or if you have any questions that this manual does not answer, please contact us right away. See the Contact Us section for more info.

Thank you!

Eric Vanzo
Customer Experience Manager

User Guide Conventions

The following icons are used in this guide to convey specific types of information:

- Very important information (can save you time!)
- Good to know info but may not apply to you

Pour des instructions en français, scannez les codes QR dans la section suivante.

Para obtener instrucciones en español, escanee los códigos QR en la siguiente sección.

B Before You Begin

Please note: this is a quick start guide, intended to get you started on the installation of your Sprinkler Controller. Download the full Installation & User Guide by scanning this QR code:



Installation & User Guide

You can also find all guides and additional resources, such as videos and troubleshooting instructions, on the Sprinkler Controller Product Support page by scanning the QR code below or by visiting:

<https://shop.yosmart.com/pages/sprinkler-controller-product-support>



Product Support
Support produit
Soporte de producto



Your Smart Sprinkler Controller connects to the internet via a YoLink hub (SpeakerHub or the original YoLink Hub), and it does not connect directly to your WiFi or local network. In order for remote access to the device from the app, and for full functionality, a hub is required. This guide assumes the YoLink app has been installed on your smartphone, and a YoLink hub is installed and online (or your location, apartment, condo, etcetera, is already served by a YoLink wireless network).



The Smart Sprinkler Controller is intended to replace an existing sprinkler controller. A 1 amp 24VAC transformer or power supply is required, but not included.

C In the Box



Smart Sprinkler Controller

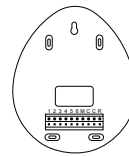

Base

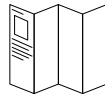

Quick Start Guide



Wall Screws (4) & Drywall Anchors (4)

D Required Items

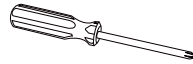

Medium Phillips Screwdriver

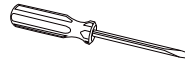

Extra Small Straight Screwdriver



Wire Strippers or Cutters



Wall Anchors

E Get to Know Your Smart Sprinkler Controller

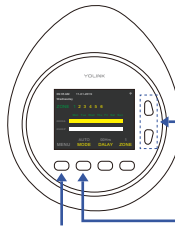

Menu Button
Access to all Settings

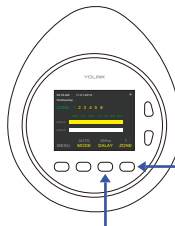

Delay Button
Switch to delay upcoming watering times

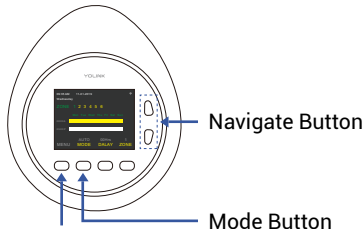

Navigate Button

Mode Button
Switch between 3 Watering Modes (Auto, Manual, Off)

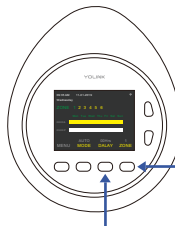

Zone Button
Switch to view watering process for each available zone

E Get to Know Your Smart Sprinkler Controller, Cont.

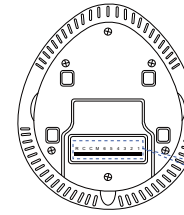

R: Live wire;
C: Common wire
M: Master valve;
1-6: Zone wires



F Install the App

If you are new to YoLink, please install the app on your phone or tablet, if you have not already. Otherwise, please proceed to the next section.

Scan the appropriate QR code below or find the "YoLink app" on the appropriate app store.



Apple phone/tablet
iOS 9.0 or higher



Android phone or tablet 4.4 or higher

Open the app and tap **Sign up** for an account. You will be required to provide a username and a password. Follow the instructions, to set up a new account. Allow notifications, when prompted.

You will immediately receive a welcome email from no-reply@yosmart.com with some helpful information. Please mark the yosmart.com domain as safe, to ensure you receive important messages in the future.

Log in to the app using your new username and password.

The app opens to the **Favorite** screen. This is where your favorite devices and scenes will be shown. You can organize your devices by room, in the **Rooms** screen, later.

G Add Your Sprinkler Controller to the App

1. Tap **Add Device** (if shown) or tap the scanner icon:

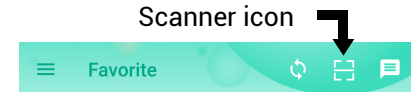

2. Approve access to your phone's camera, if requested. A viewfinder will be shown on the app.

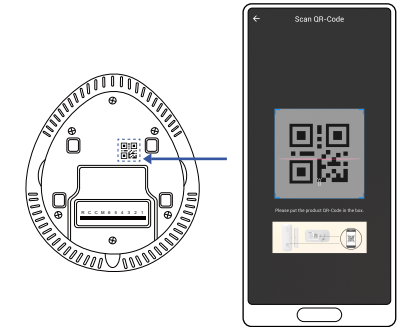

3. Hold the phone over the QR code so that the code appears in the viewfinder. If successful, the **Add Device** screen will be displayed.

You can change the device name and assign it to a room later. Tap **Bind device**.

If successful, a screen similar to the one shown below will be displayed. Tap **Done**.

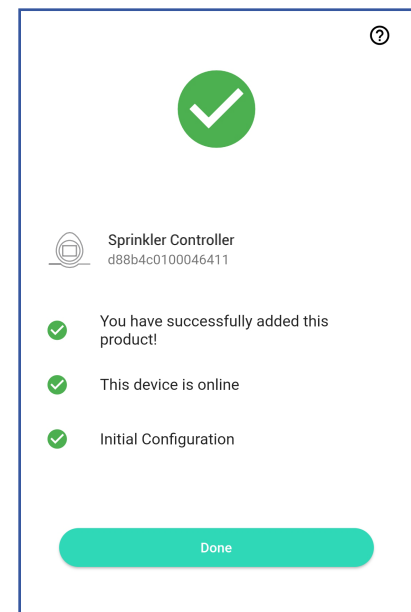

1. Turn off, remove or disconnect the 24VAC power supply to be used for your new Sprinkler Controller.

2. If you are replacing an existing controller, identify and label all of the existing wires. It may help later if you take a picture of the wires before you remove any.

3. Using care to not let any wires fall back into the wall (if applicable), loosen the wires and remove them from the existing controller.

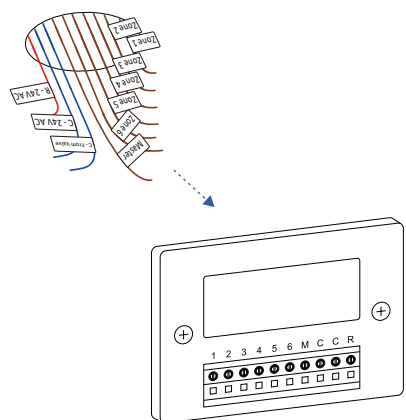

4. Place the controller base at the desired location, then mark (with pencil, tape, etc.) an outline of the controller on the wall for future reference.

5. Mount the base by screwing it in to the wall, using the supplied screws (or your own specialty anchors and screws, as needed).

6. Loosen the terminal screws on the mounting plate, preparing them for the wiring.

7. Working with one wire at a time, connect the wiring in the correct order to their respective terminals. If needed, re-strip the end of the wire, so that the conductor makes an electrical connection with the terminal screw. Tighten each screw before moving to the next.

8. Gently tug on each wire, to ensure the wire is secured and not loose.

9. Gently push the sprinkler controller onto the base. You may hear an audible snap. Ensure the controller is fully-seated on the base, by gently pulling at the edges of the controller. Uneven gaps between it and the wall may indicate the controller is not properly secured to the base.

10. Turn on the 24VAC transformer or power supply. The Sprinkler Controller should turn on, and the display should illuminate.

Refer to the full Installation & User Guide, to complete the setup and configuration of your Sprinkler Controller.

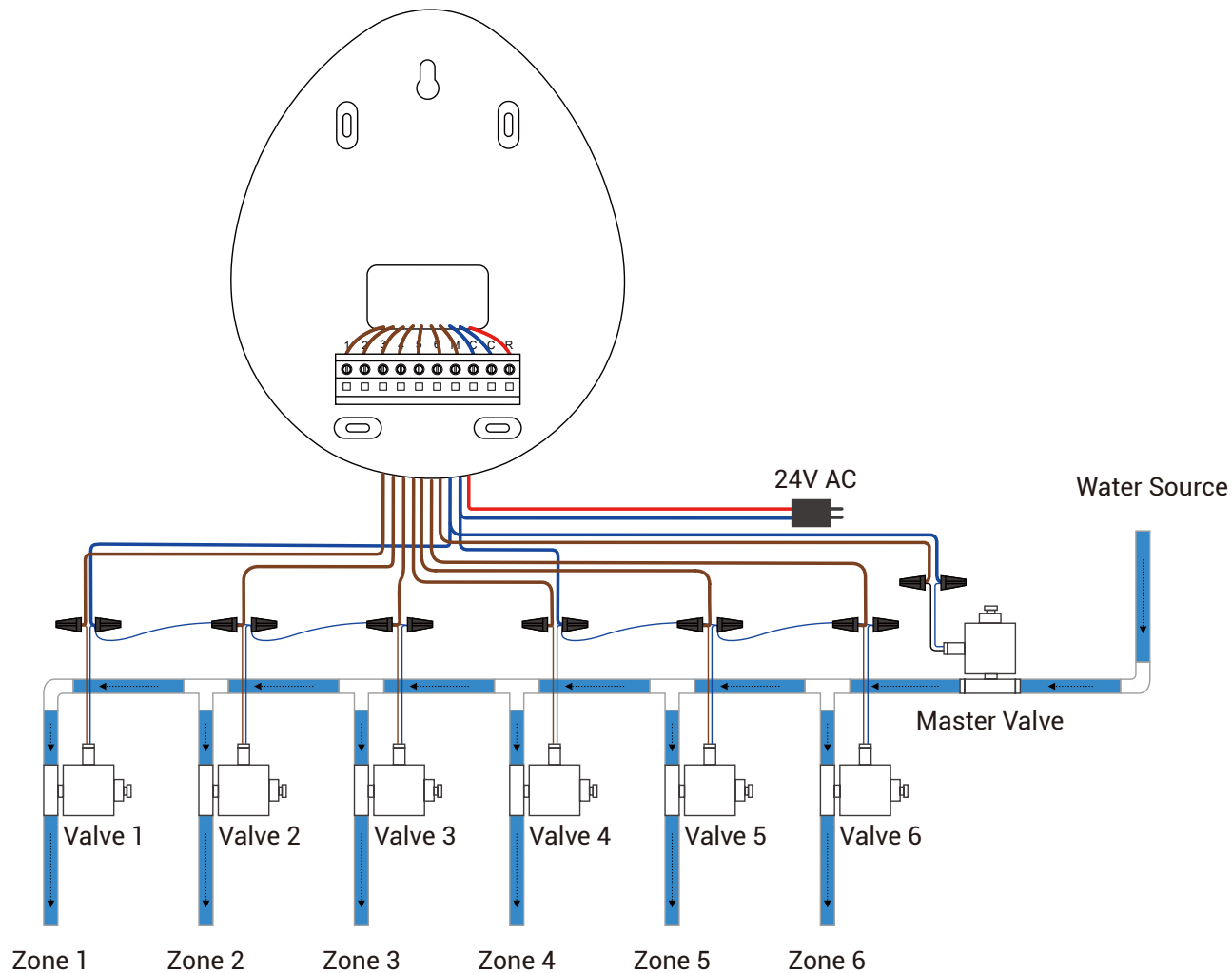

Wiring Diagram

We are here for you, if you ever need any assistance installing, setting up or using a YoLink app or product!

Need help? For fastest service, please email us 24/7 at service@yosmart.com

Or call us at **831-292-4831** (US phone support hours: **Monday - Friday, 9AM to 5PM** Pacific)

You can also find additional support and ways to contact us at: www.yosmart.com/support-and-service

Or scan the QR code:



Support Home Page

Finally, if you have any feedback or suggestions for us, please email us at feedback@yosmart.com

Thank you for trusting YoLink!

Eric Vanzo
Customer Experience Manager



15375 Barranca Parkway
Ste. J-107 | Irvine, California 92618

© 2022 YOSMART, INC IRVINE,
CALIFORNIA