

## Water Depth Sensor

YS7905-UC

Quick Start Guide

Revision May. 10, 2023

### A Welcome!

Thank you for purchasing YoLink products! We appreciate you trusting YoLink for your smart home & automation needs. Your 100% satisfaction is our goal. If you experience any problems with your installation, with our products or if you have any questions that this manual does not answer, please contact us right away. See the Contact Us section for more info.

Thank you!

Eric Vanzo  
Customer Experience Manager

The following icons are used in this guide to convey specific types of information:

 Very important information (can save you time!)

 Pour des instructions en français, scannez les codes QR dans la section suivante.

 Para obtener instrucciones en español, escanee los códigos QR en la siguiente sección.

### B Before You Begin

Please note: this is a quick start guide, intended to get you started on the installation of your Water Depth Sensor. Download the full Installation & User Guide by scanning this QR code:



Installation & User Guide

You can also find all current guides and additional resources, such as videos and troubleshooting instructions, on the Water Depth Sensor Product Support Page by scanning the QR code below or by visiting:

<https://shop.yosmart.com/pages/water-depth-sensor-product-support>



Product Support  
Support produit  
Soporte de producto



Your Water Level Monitoring Sensor connects to the internet via a YoLink hub (SpeakerHub or the original YoLink Hub), and it does not connect directly to your WiFi or local network. In order for remote access to the device from the app, and for full functionality, a hub is required. This guide assumes the YoLink app has been installed on your smartphone, and a YoLink hub is installed and online (or your location, apartment, condo, etcetera, is already served by a YoLink wireless network).

### C Included

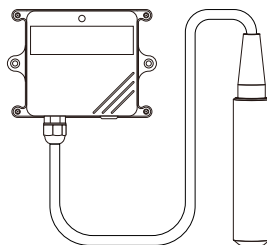

Water Depth Sensor

### C Included, Continued

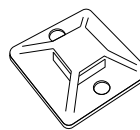

4 x Cable Tie Mount



8 x Cable Tie

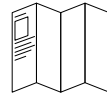

Quick Start Guide



1 x ER34615  
Battery  
Pre-Installed

### D Required Items

The following items may be required:



Screws and  
Anchors

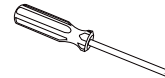

Medium Phillips  
Screwdriver



Drill with Drill Bits







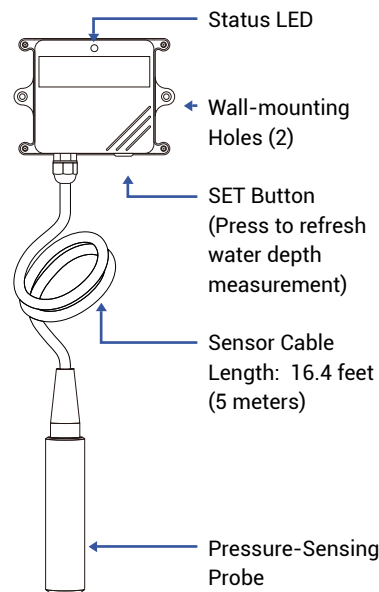

Double-sided  
Mounting Tape

### E Get to Know Your Water Depth Sensor



### E Get to Know Your Water Depth Sensor, Continued

LED Behaviors

-  **Blinking Red Once, Then Green Once**  
Device Start-Up
-  **Blinking Red and Green Alternately**  
Restoring to Factory Defaults
-  **Blinking Red Once**  
Updating Water Depth Measurement
-  **Quick Blinking Green**  
Control-D2D Pairing in Progress
-  **Quick Blinking Red**  
Control-D2D Unpairing in Progress
-  **Slow Blinking Green**  
Updating
-  **Fast Blinking Red Once Every 30 Seconds**  
Low Battery, Replace Batteries Soon

### F Power Up

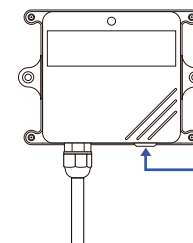

To power up the sensor for the first time, press the SET button briefly, until the LED flashes red, then green.

### G Install the App

If you are new to YoLink, please install the app on your phone or tablet, if you have not already. Otherwise, please proceed to the next section.

Scan the appropriate QR code below or find the "YoLink app" on the appropriate app store.



Download on the  
App Store

Available on  
Google Play

Apple phone/tablet  
iOS 9.0 or higher

Android phone/  
tablet 4.4 or higher

## G Install the App, Continued

Open the app and tap **Sign up** for an account. You will be required to provide a username and a password. Follow the instructions, to set up a new account. Allow notifications, when prompted.

You will immediately receive a welcome email from [no-reply@yosmart.com](mailto:no-reply@yosmart.com) with some helpful information. Please mark the [yosmart.com](http://yosmart.com) domain as safe, to ensure you receive important messages in the future.

Log in to the app using your new username and password.

The app opens to the **Favorite** screen. This is where your favorite devices and scenes will be shown. You can organize your devices by room, in the **Rooms** screen, later.

Refer to the full user guide and online support for instructions on the use of the YoLink app.

## H Add Your Water Depth Sensor to the App

1. Tap **Add Device** (if shown) or tap the scanner icon:

Scanner icon



2. Approve access to your phone's camera, if requested. A viewfinder will be shown on the app.

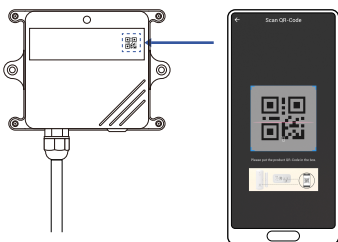

3. Hold the phone over the QR code so that the code appears in the viewfinder. If successful, the **Add Device** screen will be displayed.

4. Follow the instructions to add your Water Depth Sensor to the app.

## I Install the Water Depth Sensor

### Sensor use considerations:

The Water Depth Sensor measures the depth of water in a tank or container using a pressure sensor in the probe. The weight of the water is sensed by the probe, and this data is converted to water depth in the app. Therefore, the probe must be placed at the bottom of the tank or container it is used.

### Sensor location considerations:

Before installing your Water Depth Sensor, consider the following important factors:

1. The sensor body is designed for outdoor use, but it must not be submerged; do not install the sensor where it can possibly be submerged later. Internal water damage to the sensor is not covered by the warranty.
2. The sensor has a SET button and LED indicator that should be accessible; install the sensor at an accessible location.

### Install the Water Depth Sensor's Probe

1. Uncoil and suspend the probe into the water container. The probe should sit on the bottom of the container, in a vertical orientation as shown in the diagram.

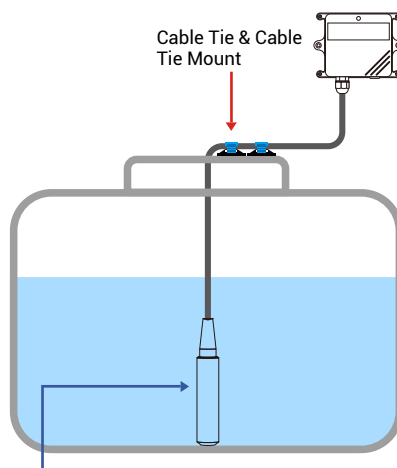

Probe should be placed at the bottom of the tank/well/container, in a vertical orientation, as shown.

## I Install the Water Depth Sensor, Continued

2. When the correct position is attained, secure the probe cable to the container sidewall, lid, or other fixed and stable surface, so that the probe position does not change. You can use cable ties and mounts to secure the probe cable, but to avoid damaging the cable, do not overtighten the ties or otherwise pinch or crimp the cable.

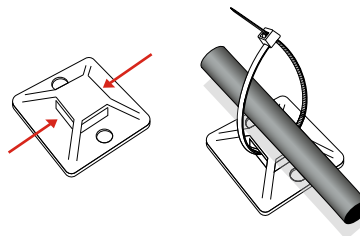

### Install the Water Depth Sensor (Main Assembly)

Determine how you will mount the sensor to the wall or surface, and have hardware and anchors appropriate for the wall surface on hand. The sensor is intended to be wall-mounted, using screws. It can be placed in another enclosure. If using alternative methods, such as mounting tape, ensure the sensor is securely installed, so as to not fall off the wall later (physical damage is not covered by the warranty).

1. Holding the sensor in position, mark the location of the sensor's two mounting holes to the wall surface.
2. If using anchors, install them, per the manufacturer's instructions.

3. Insert and tighten one screw in each of the sensor's mounting holes, ensuring the sensor is secured to the wall or mounting surface.

Refer to the full installation and user guide and/or the product support page, to complete the settings in the YoLink app.

## J Contact Us

We are here for you, if you ever need any assistance installing, setting up or using a YoLink app or product!

Need help? For fastest service, please email us 24/7 at [service@yosmart.com](mailto:service@yosmart.com)

Or call us at **831-292-4831** (US phone support hours: **Monday - Friday, 9AM to 5PM** Pacific)

You can also find additional support and ways to contact us at: [www.yosmart.com/support-and-service](http://www.yosmart.com/support-and-service)

Or scan the QR code:



Support  
Home Page

Finally, if you have any feedback or suggestions for us, please email us at [feedback@yosmart.com](mailto:feedback@yosmart.com)

Thank you for trusting YoLink!

Eric Vanzo  
Customer Experience Manager

**YOLINK**

15375 Barranca Parkway  
Ste. J-107 | Irvine, California 92618

© 2023 YOSMART, INC IRVINE,  
CALIFORNIA